

Hot Tub Cover Measuring Guide

Print this guide to take with you to your hot tub as an easy to use reference.

I. Deciding What To Measure:

If any of the following apply to you, measure your existing cover:

- Cover must be in decent condition. Natural wear and tear is fine.
- Cover has not warped, become water logged, or changed shape since its purchase.
- You are happy with the way the current cover fits.

If any of the following apply to you, measure your hot tub:

- You have no existing cover
- Your current cover is warped, has become water logged, or changed shape since its purchase.
- Unhappy with the way your current cover fits.

II. How to Measure:

Round up measurements to nearest half inch or inch. A cover that is 1-2 inches too large will fit fine, but a cover that is too small will decrease the efficiency of the insulation. If your measurements are close to being perfectly square (ie: 78.5" x 78"), it probably is a perfect square.

III. Where to Measure:

Choose which installation type looks most like yours:

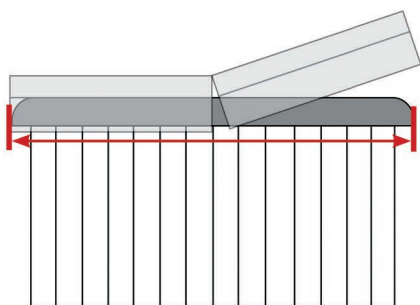

Classic spa cabinets:
Measure the widest points on the acrylic lip shown by the arrows above.

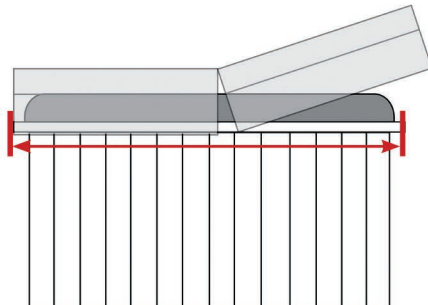

Spa cabinets with top rail:
Measure the widest points on the top rail shown by the arrows above.

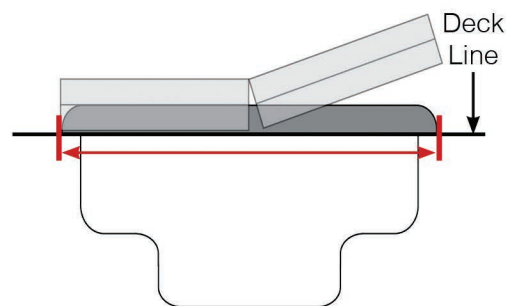

In ground spas:
Measure the widest points above ground shown by the arrows above.

Questions about hot tubs, covers or measurements? Contact us.

(800) 781-8154 | www.Spacovers.com

IV. Choose a Shape and Measure:

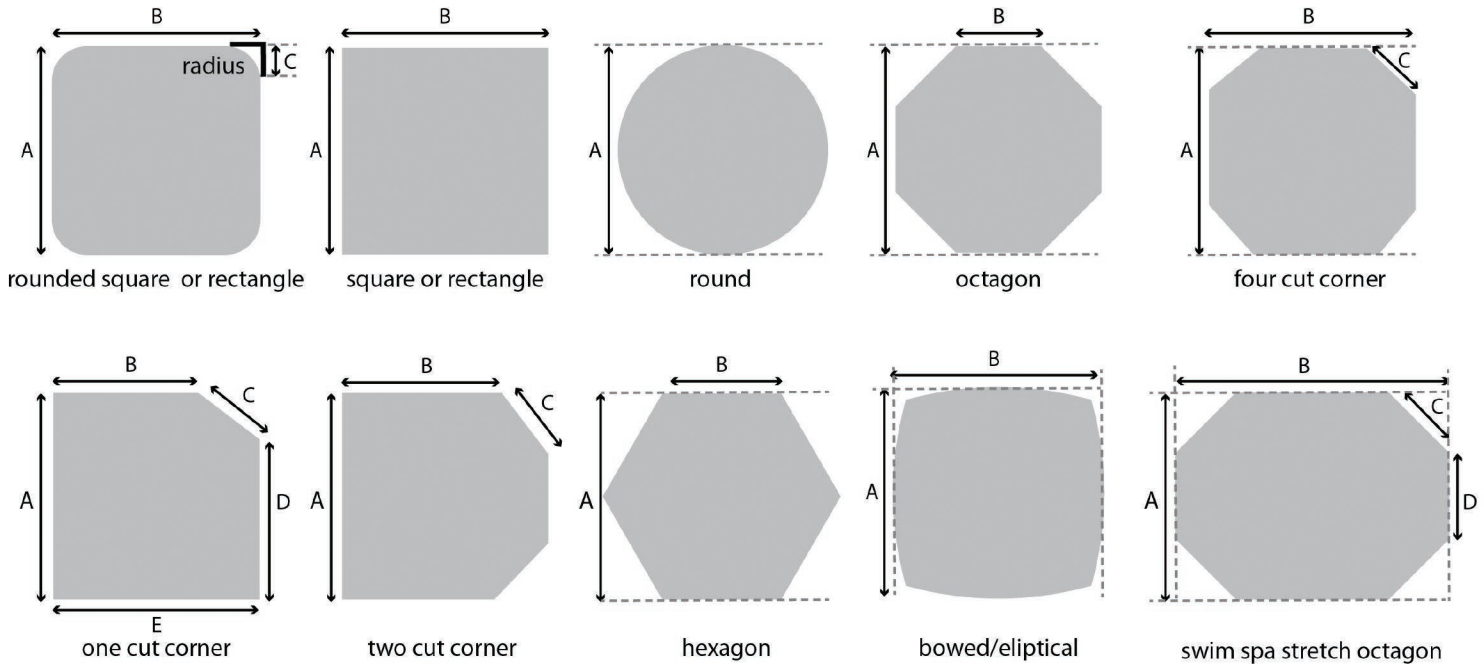

Measurements:

A _____

B _____

C _____

D _____

E _____

V. Choosing a Fold/ Hinge:

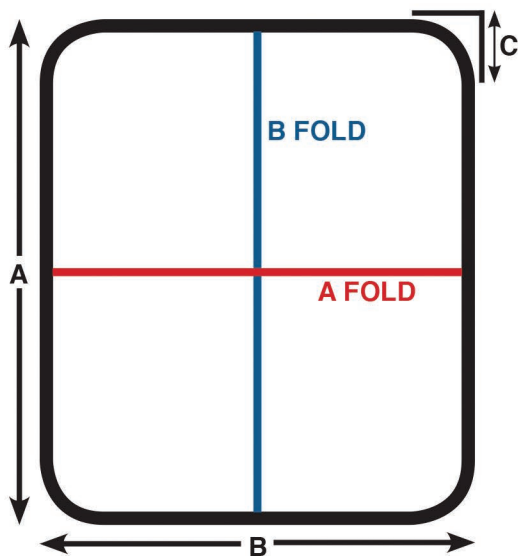

Fold Choice: _____

An "A Fold" cuts the A dimension in half, a "B Fold" cuts the B dimension in half.

If you have a cover that is perfectly square, a fold/ hinge does not need specification.

Considerations:

- Where is the control panel located? It's most common for covers to fold away from the control panel.
- The longer dimension is usually the one that gets folded in half, but this is not always the case.
- Ask yourself: Is there anything obstructing the path of the cover opening and closing that would change the hinge? (ie: fence)

Questions about hot tubs, covers or measurements? Contact us.

(800) 781-8154 | www.Spacovers.com

VI. The Corner Radius:

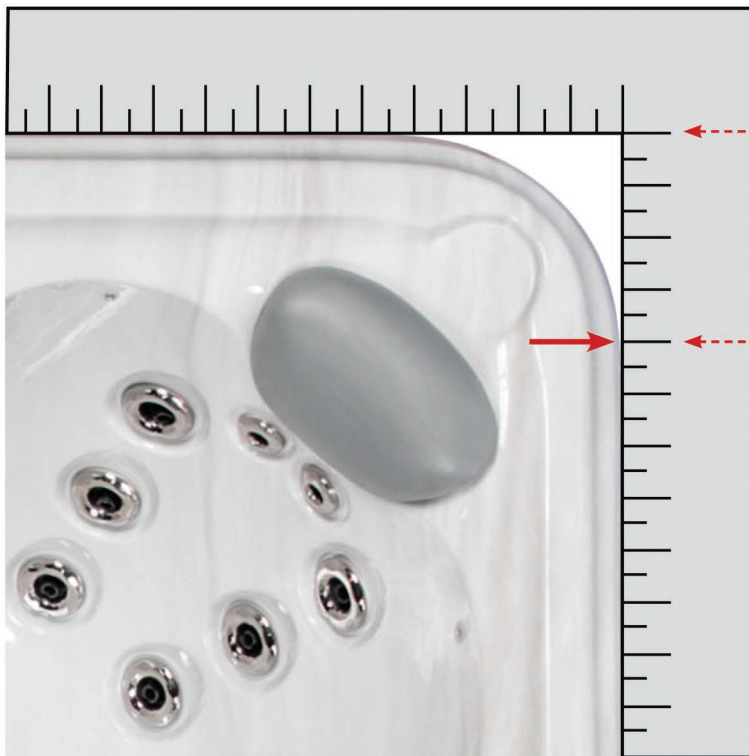

Using a carpenter's square:

Point of Extended Corner

The **radius** is the measurement between the point of the extended corner to the beginning of the curve.

Beginning of the curve radius

Note: You might consider specifying a slightly smaller radius.

A smaller radius, due to the change in curve, will extend the cover out further past the corner of your spa. 1/2" less radius extends the cover 1/4" further

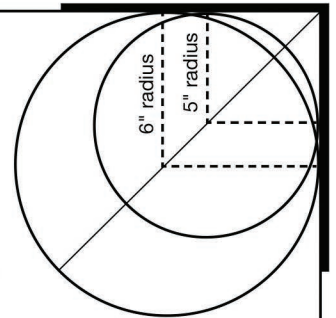

If you don't have a square handy:

Use pieces of wood, cardboard or anything with a straight edge.

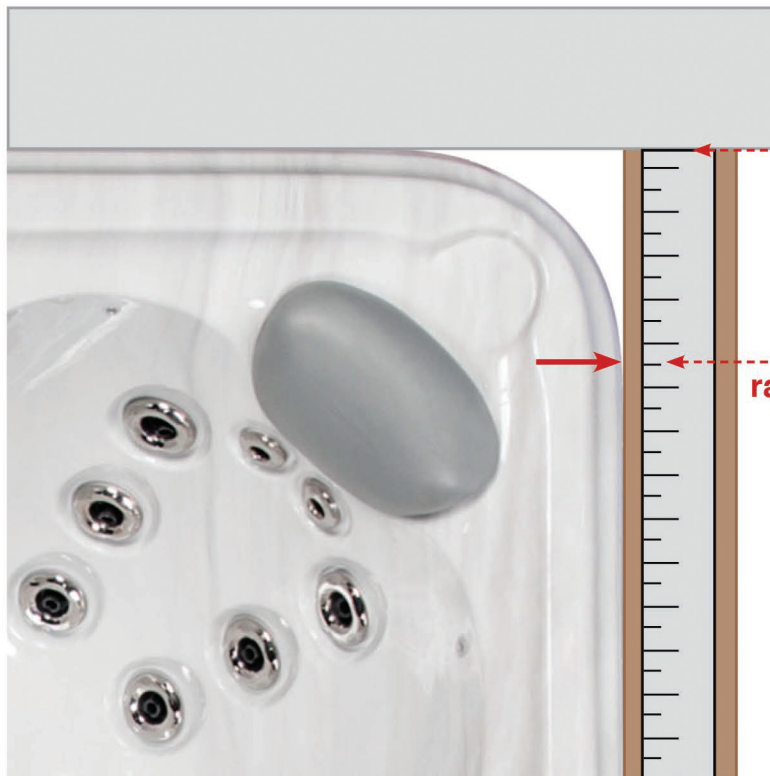

Point of Extended Corner

measure the distance for the radius with ruler or tape measure

Beginning of the curve radius

Your Radius Measurement: _____

Questions about hot tubs, covers or measurements? Contact us.

(800) 781-8154 | www.SpaCovers.com

VII. Measuring the Skirt and Strap:



Cover Skirt Length: _____

A 5" standard skirt length will be used if no custom length is requested.

The cover skirt is the flap that hangs around the edge from the bottom of your cover. Measure the skirt of your spa from the bottom of the cover down. For no skirt, enter zero; the minimum length for a skirt is 1.5".

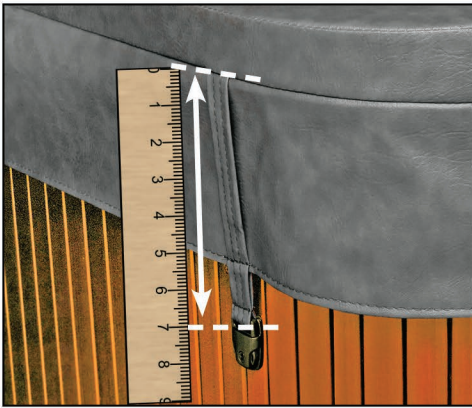

Safety Strap Length: _____

A 7" standard strap length will be used if no custom length is requested.

To get an accurate measurement of the safety strap, you need to measure it from the bottom of the cover down and include the skirt length but not the clip. The strap needs to hang at least 1.5" below the skirt. It is also good to note that due to production variations it cannot be guaranteed you will receive a matching strap placement. Straps are required on every cover.

VIII. Additional Notes:

Cabinet/ Panel Type:

Wood

Synthetic

Pop Up Speakers:

YES

NO

Questions about hot tubs, covers or measurements? Contact us.

(800) 781-8154 | www.Spacovers.com

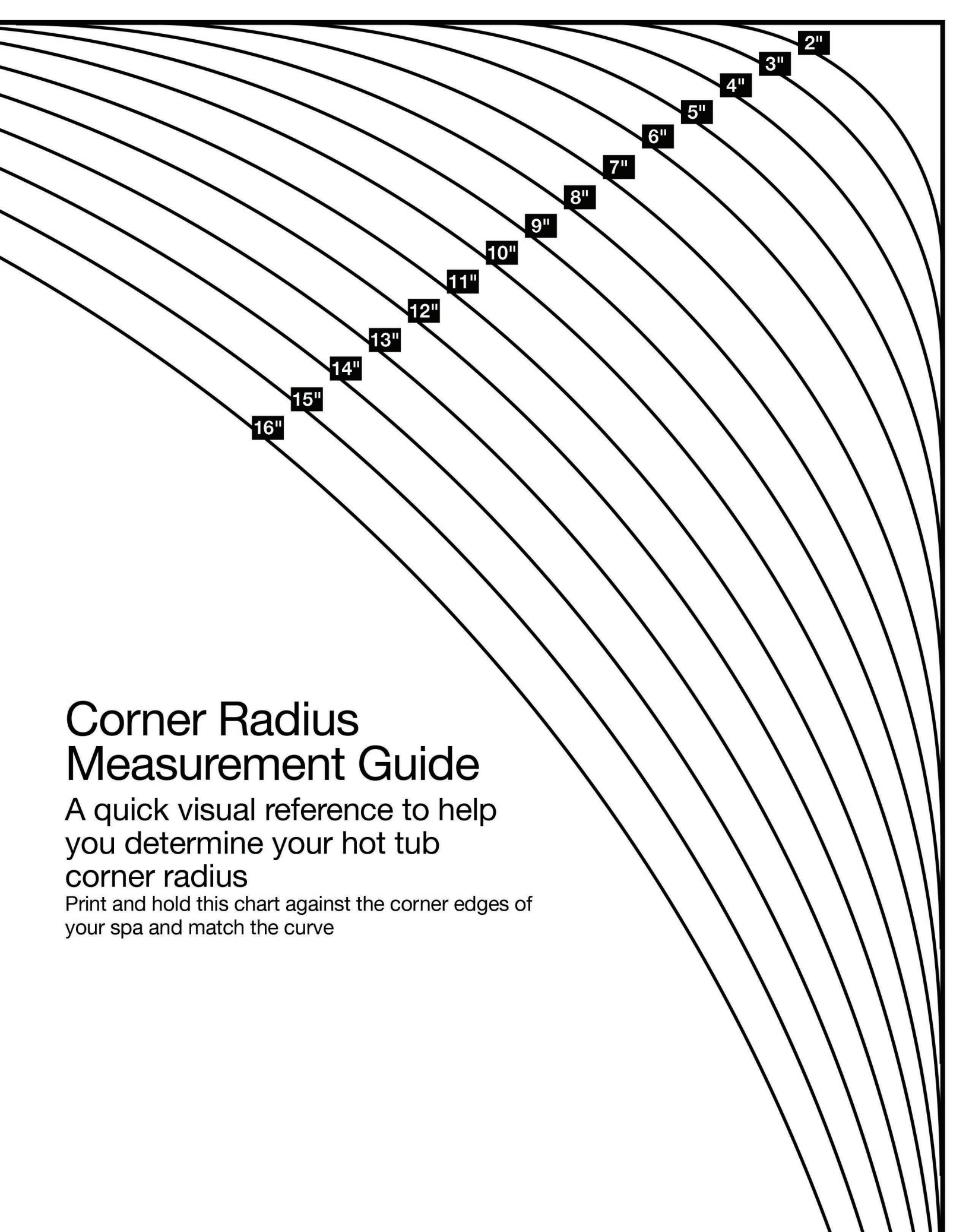

Corner Radius Measurement Guide

A quick visual reference to help
you determine your hot tub
corner radius

Print and hold this chart against the corner edges of
your spa and match the curve